

APV ParaFlow Plate Heat Exchangers

FOR HVAC APPLICATIONS



SPX offers an extensive portfolio of plate heat exchangers covering many industrial applications. Regularly SPX heat exchangers replace older technology products due to the simplicity of installation and their high performance thermal characteristics. Whether recovering waste heat or isolating the cooling system from the cooling source, SPX has the application knowledge and product to improve efficiency and performance.

Our vision for the future is rooted in a long standing tradition of excellence and commitment to progress. We strive to offer the customer the highest quality products and services today, tomorrow and beyond.

SPX provides advanced APV heat transfer solutions for cooling, heating, condensing and evaporation of process fluids - designed to solve heat transfer process challenges in a vast array of industries. They are designed to meet demanding process conditions and to optimize the utilisation of energy. APV heat transfer solutions have proven reliable and highly efficient helping customers worldwide to run their processes safely and economically. Dedicated and specialized SPX staff around the world is committed to design and provide efficient and durable heat transfer solutions to help customers optimize energy utilization and minimize downtime for improved profitability.

Technology, Performance & Value

APV is a leading innovator of solutions specifically designed to meet the challenges of the HVAC market.

APV provides a broader selection of plate sizes and corrugation patterns — offering the greatest number of options and thermal lengths, ensuring you get the solution that best meets your needs.

ADVANTAGES FOR HVAC APPLICATIONS

- Reduced operating and maintenance costs
- Compact size
- Modular design facilitates installation in areas where space is limited
- Flow rates up to 11,000 GPM
- Design pressures to 400 PSI
- High efficiency design for smaller heat exchangers with lower pressure drops
- Computerized thermal rating optimizes plate types for maximum efficiency
- Full ASME code compliance

WATER SOURCE HEAT PUMP

Today, heat pumps are widely used in HVAC applications. An open cooling tower is typically combined with a plate heat exchanger as the preferred alternative to closed circuit coolers. With the APV Paraflow you can be assured that contaminated water from sources such as open cooling towers, water wells, streams and lakes will be isolated from the closed loop heat pump system.

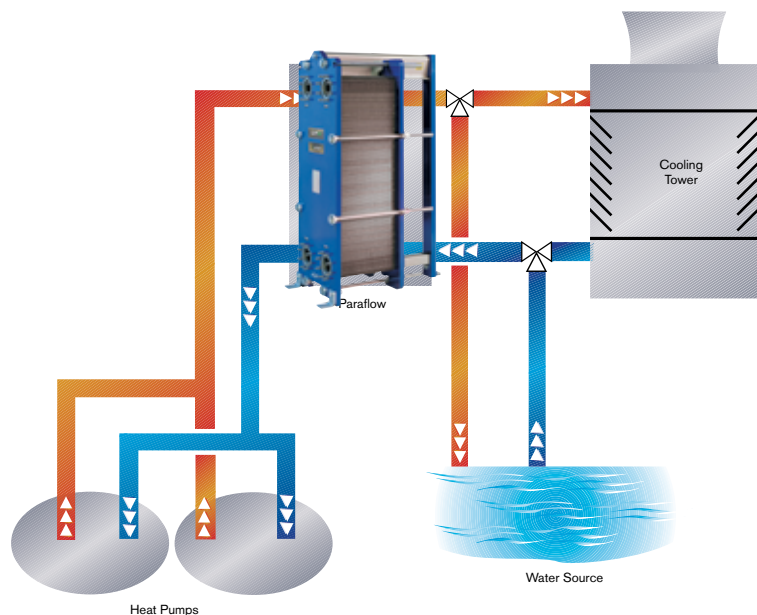

THERMAL STORAGE

Thermal storage systems are being used to efficiently manage peak building cooling loads. During the night, the chiller capacity is used to cool water or produce ice in a thermal storage reservoir. During the day, when loads are at their peak, the “stored cooling” is used to handle the demand. The thermal storage system will reduce utility costs as the chiller is operated at night when energy rates are lower. Mechanical equipment loading is also minimized through the use of this system. Since glycol or brines are often used in the chillers, the Paraflow is used to isolate these fluids from the rest of the system and act as a pressure block to the storage reservoirs.

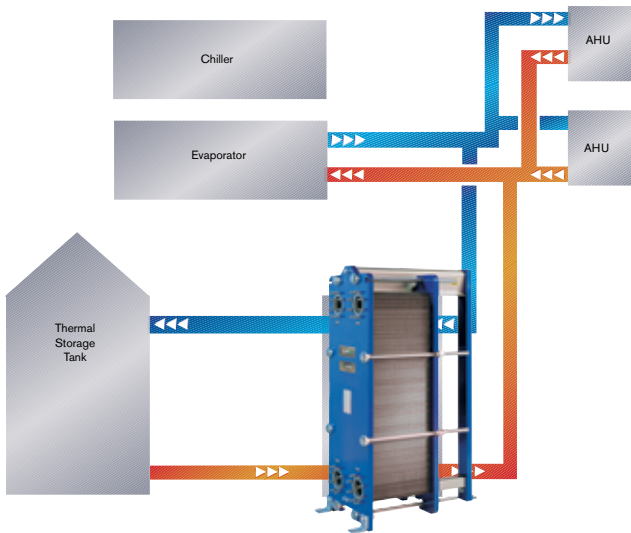

Typical product applications

Free cooling

Heat recovery

Water source heat pump

Thermal storage

Pressure interceptor

District heating and cooling



FREE COOLING

A waterside economizer system using a Paraflow plate heat exchanger will save thousands of hours of mechanical refrigeration, which translates to tremendous bottom-line benefits. Using the free cooling available in the outside air under optimum wet bulb conditions, this system delivers cooling tower water with a temperature that minimizes chiller operation. The key is the highly efficient Paraflow plate heat exchanger, which provides heat transfer and simultaneously isolates and protects expensive air conditioning equipment from tower water contamination.

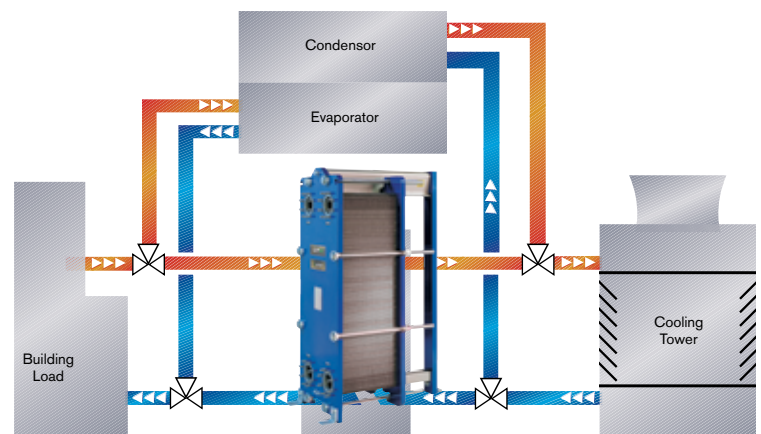

SYSTEM ADVANTAGES

- In most cases payback is in less than 18 months
- Lower energy costs and longer chiller life
- High efficiency and less maintenance through prevention of contamination and fouling in the building chilled water system
- Eliminates duct work required for air-side economizers, saving space and money
- No moving parts minimizes maintenance
- Paraflow meets retrofit demands of existing structures
- High efficiency allows close approach temperatures (i.e. 2°F), increasing your hours of free cooling
- Example: Fort Bragg, NC

$$380 \text{ tons} \times .90 \text{ KW/ton} = 342 \text{ KW}$$

$$342 \text{ KW} \times 1734 \text{ hrs (37° wb or lower)} = 593,028 \text{ KWH}$$

$$593,028 \text{ KWH} \times \$.05/\text{KWH} = \$29,651/\text{yr}$$

APPROXIMATE HOURS OF OPERATION			
STATE	CITY	47° WB 7 A.M. - 7 P.M.	38° WB 7 A.M. 7 A.M. - 7 P.M.
ALABAMA	Birmingham	1,848.2 1,009	800.6 427
ALASKA	Anchorage	6112.4 3,378	4,733.6 2,612
ARIZONA	Phoenix	1,722.9 939	167 75
CALIFORNIA	Sacramento	620.6 327	183.2 84
COLORADO	Denver	4,373.6 2,412	3,014.6 1,657
GEORGIA	Atlanta	2,255 1,235	1,065.2 574
ILLINOIS	Chicago	3,833.6 2,112	3,178.4 1,748
KENTUCKY	Lexington	2,847.2 1,564	1,808.6 987
MASSACHUSETTS	Boston	4,145 2,285	3,043.4 1,673
MICHIGAN	Detroit	4,305.2 2,374	3,398 1,870
MINNESOTA	Duluth	5,210.6 2,877	4,224.2 2,329
MISSISSIPPI	Jackson	1,526 831	615.2 324
NEVADA	Las Vegas	2,145.2 1,174	780.8 416
NEW HAMPSHIRE	Portsmouth	4,231.4 2,333	3,245 1,785
NEW JERSEY	Cherry Hill	3,619.4 1,993	2,418.8 1,326
NEW YORK	Buffalo	4,130.6 2,277	3,279.2 1,804
OHIO	Cincinnati	3,547.3 1,953	2,494.4 1,368
OKLAHOMA	Tulsa	2,750 1,410	1,459.4 793
OREGON	Portland	3,421.4 1,883	989.6 532
VIRGINIA	Richmond	2,739.2 1,504	1,551.2 844

°F
°C

ENERGY SAVINGS CALCULATIONS

The following information must be known:

- Approximate winter tonnage
- Efficiency of chiller
- Hours of operation at winter design wet bulb
- Approach temperature between cooling tower water and building chilled water temperatures (i.e. 37°F tower water @ 2°F approach, nets a building water temperature of 39°F).

PRESSURE INTERCEPTOR

In tall buildings, HVAC systems that use water, glycol and brine often experience problems with pressure build-up from static head. The Paraflow plate heat exchanger is used at various elevations to create separate circulation loops and reduce the operating pressure throughout the system. The lower operating pressure allows you to use standard equipment for pumps, valves, chillers and evaporators. Energy savings in pump horsepower can also be achieved.

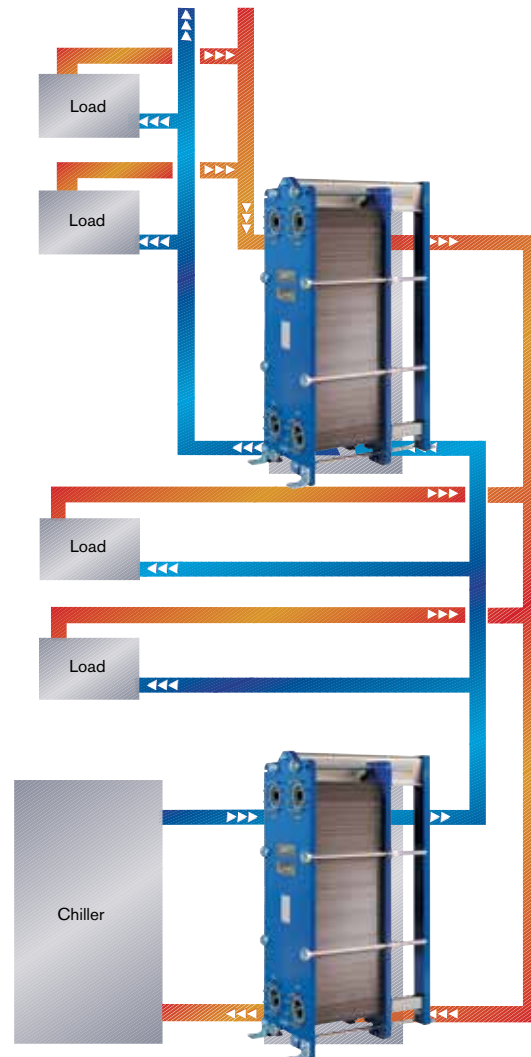

DISTRICT HEATING AND COOLING

The Paraflow PHE can be used in low pressure steam, hot water and chilled water district heating and cooling systems. The savings realized, incorporating one large centralized plant rather than many small units, is evident over time.

The Paraflow is used as an instantaneous heater and separation device from the main loop in each building. Hot or chilled water is sent to each building via the insulated pipes from the central plant.

The heat exchanger transfers the heat to the closed freshwater loops circulating through each building. This provides isolation and pressure interception for the water loops. It also provides a constant pressure drop for the central plant.

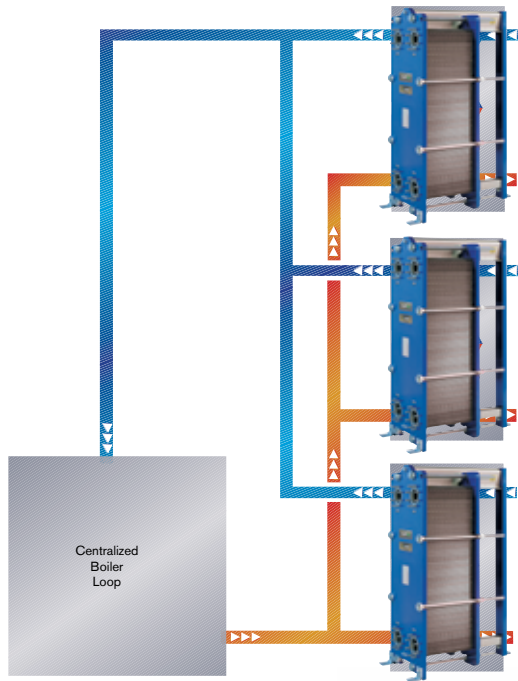

LAKE SOURCE COOLING

A good example of Lake Source Cooling is a Northeast University needed to replace their campus cooling system that dated back to the early 1960s. Several of their chillers used chlorofluorocarbons (CFCs), which could not be converted to non-CFC refrigerants. As they explored their options, they began to seriously consider the installation of a lake-source cooling system. After extensive testing and environmental review, the university decided to move forward with the lake source cooling system to cool all of the buildings throughout campus.

HOW IT WORKS:

Cold lake water is pumped to APV heat exchangers at the shore, which absorbs some of the heat from the water used to cool the University, then returns to shallow waters in the lake. The deep waters of the lake are a naturally renewable source of chilled water that saves 80% of the energy used to cool by conventional refrigeration. The closed loop system also minimizes the required energy needed to operate, since the return water coming down the hill to the lake shallows creates a vacuum which pulls the deep cold water from the lake up to the campus. The core of the system consists of seven 12" 300 PSIG APV heat exchangers that are in parallel arrangement, allowing any combination of pumps and heat exchangers to be on line to meet the requirements to control the comfort of 75 campus buildings.

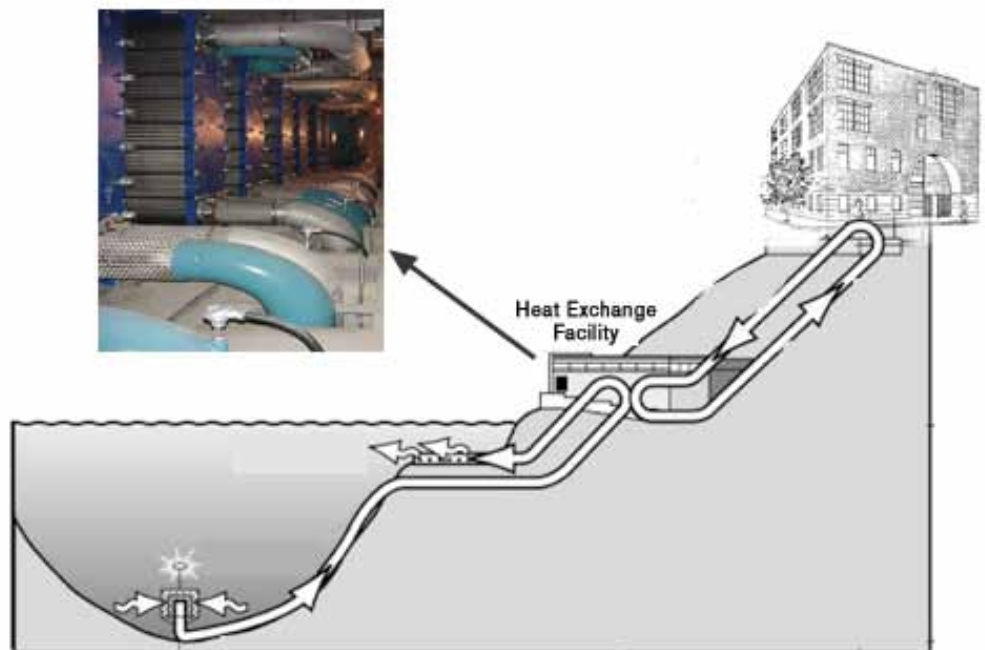

HEAT RECOVERY FROM CONDENSER WATER

Heat contained in condenser water can be recovered using a Paraflow plate heat exchanger between the condenser and the cooling tower. The highly efficient Paraflow captures the “free heat,” preheats domestic and building water, and reduces the load to the cooling tower.

FROM WASTE HEAT

The Paraflow allows you to recover heat from sources such as institutional buildings which consume large amounts of hot water, offices where heat is generated by building occupants and equipment, as well as commercial and manufacturing complexes producing heat from machinery and process liquids. In the absence of a PHE heat recovery unit, millions of BTUs would be exhausted into the surrounding environment and be wasted.

START BENEFITING TODAY

APV plate heat exchangers minimize downtime while reducing maintenance time and expenses, delivering all the benefits you need to improve your profitability. SPXs experienced engineers will work with you every step of the way from system design to implementation, to ensure you get the solution that best meets the needs of your process.

To learn more about how SPX can help you improve your profitability, call us today at +1-800-207-2708.

From Condenser Water

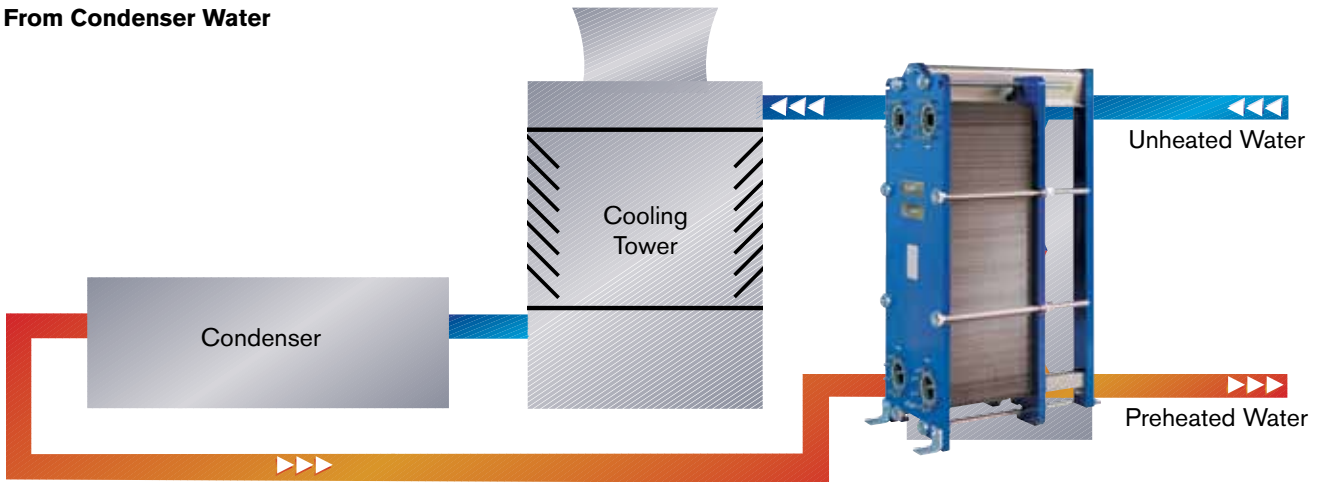

From Waste Water





PRODUCT PORTFOLIO



5 FT
1.5 M

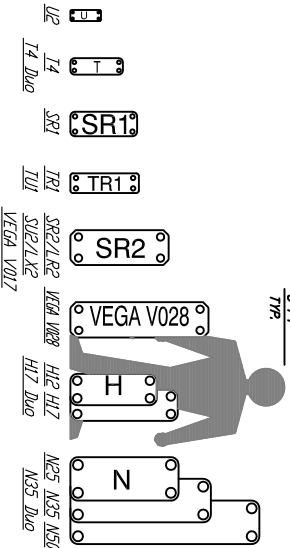

PARAFLOW

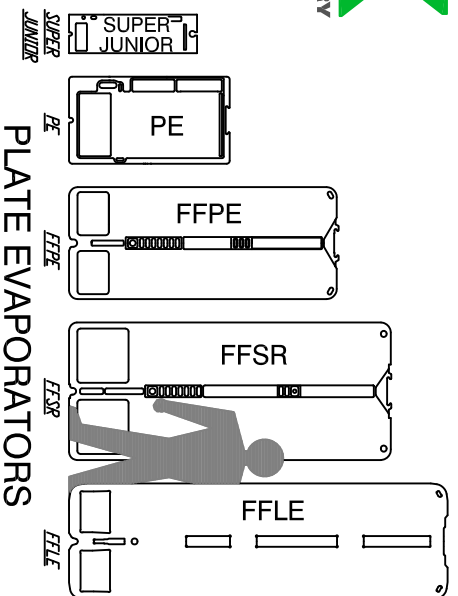
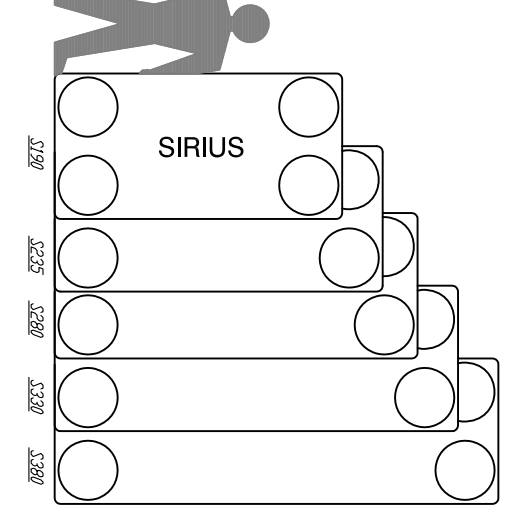
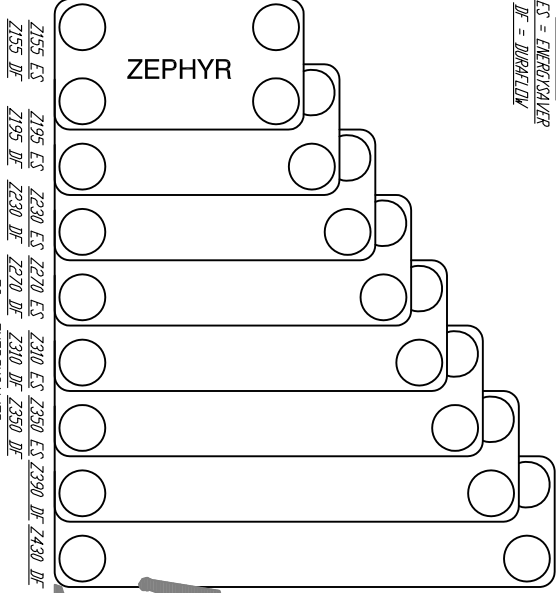
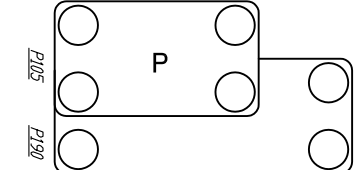
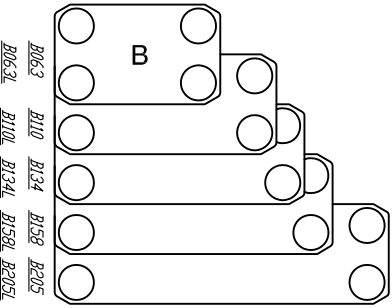
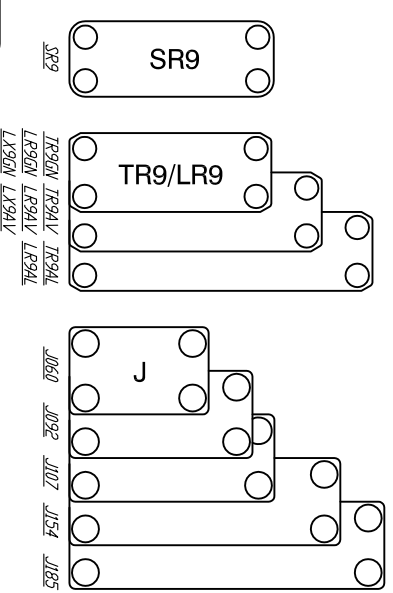
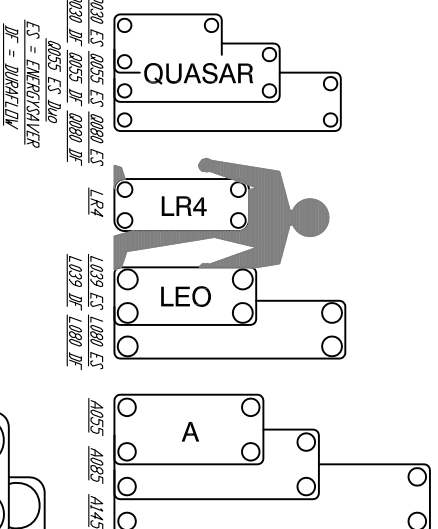
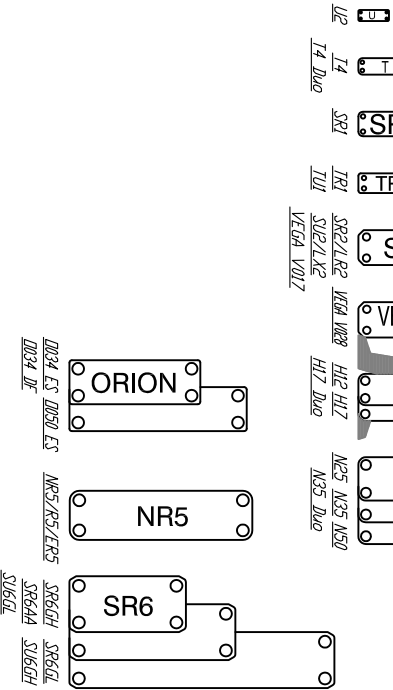

PLATE EVAPORATORS



DDO-SPX3100E

APV ParaFlow Plate Heat Exchangers

FOR HVAC APPLICATIONS



Global locations

SPX FLOW TECHNOLOGY

1200 West Ash Street
P.O. Box 1718
Goldsboro, NC 27533-1718
USA
T: +1 (919) 735-4570
F: +1 (919) 731-5498
E-mail: answers.us@spx.com

SPX FLOW TECHNOLOGY

Platinvej 8
6000 Kolding
Denmark
T: +45 70 278 444
F: +45 70 278 445
E-mail: apv.emea.heat@spx.com

SPX FLOW TECHNOLOGY

666 Fengjin Road
Xidu Industrial Park
Fengxian
P.R. China.
Tel: +86 21 67158181
Fax: +86 21 67158282

ABOUT SPX

Based in Charlotte, North Carolina, SPX Corporation (NYSE: SPW) is a global Fortune 500 multi- industry manufacturing leader. For more information, please visit www.spx.com

SPX FLOW TECHNOLOGY

105 CrossPoint Parkway
Getzville, NY 14068
P: (800) 462-6893
F: (716) 692-1715
E: answers.us@spx.com



Sesinoks Metal ve End. Ürünler San.Tic. A.Ş.
Dudullu OSB 2. Cad. No: 20 Ümraniye - İSTANBUL - TR
Tel: +90 216 420 10 00 Fax : +90 216 420 74 39
www.sesinoks.com.tr info@sesinoks.com.tr

SPX reserves the right to incorporate our latest design and material changes without notice or obligation.

Design features, materials of construction and dimensional data, as described in this bulletin, are provided for your information only and should not be relied upon unless confirmed in writing. Please contact your local sales representative for product availability in your region. For more information visit www.spx.com.

The green ">" is a trademark of SPX Corporation, Inc.

ISSUED 12/2012 1102-01-08-2008-US

COPYRIGHT © 2012 SPX Corporation